



LFP12.8-8

Lithium iron phosphate battery



LITHIUM SERIES

Characteristics

Electrical		
Nominal voltage		12.8V
Nominal capacity at 5 hours rate (25°C)		8Ah
Energy		102Wh
Charge Efficiency at 0.2C (25°C)		99.5%
Discharge Efficiency at 1C (25°C)		96-99%
Approx. internal resistance (25°C)		≤150 mΩ
Cycle life / 0.2C 100% D.O.D		>3000 cycles
Capacity affected by temperature	40°C	101%
	25°C	100%
	0°C	90%
	-10°C	75%
Mechanical		
Dimensions	Length	151±1.5mm (5.94inch)
	Width	65±1mm (2.56inch)
	Height	97±1mm (3.82inch)
	Total height	100±1mm (3.94inch)
Terminal type		T2
Torque		N/A
Weight		1.05kg (2.31lbs)±4%
Water & Dust resistance		IP64
Battery container ABS UL94-HB		V-0 optional
Cell strings		4 strings
Temperature		
Nominal operating temperature		25°C±3 (77±5°F)
Operating temperature range	Discharge	-20°C~60°C (-4°F~140°F)
	Charge	0°C~45°C (32°F~113°F)
	Storage	0°C~40°C (32°F~104°F)
Charging		
Charging voltage at 25°C		14.6V
Standard charge mode (25°C±2°C, <75%RH)		0.2CA Constant Current to 14.6V, then Constant Voltage 14.6V until the current drops to 0.02CA. Rest 30 minutes before use.
Nominal charging current		2A
Maximum charging current		4A
Charging cut-off voltage		14.6V
Discharging		
Continuous discharge current		20A
Maximum pulse discharge current (<100ms)		24A
Discharge cut-off voltage		11.2V
Self discharge rate (25°C)		≤3%/month
Communication & connection		
Communication protocol (optional)		N/A
SOC (optional)		N/A
Maximum modules in paralel or series		1 string 1 parallel

Overview

NPP Power Lithium-Iron Phosphate batteries offer superb improvement in characteristics compared to lead-acid technology. Due to the extreme cycle and calendar life, LiFePO₄ batteries are an excellent long-term investment for your applications. Powerful, lightweight, safe, and smart, the Lithium-Iron Phosphate batteries are the future of the energy storage you can have right now.

Features

- Longer cycle life** - Up to 15 times longer cycle life and 5 times longer float/calendar life than lead-acid batteries.
- More capacity** - Provides up to 100% of usable energy.
- Lightweight** - 60% lighter than lead-acid batteries.
- High discharge rate** - Ability to fully discharge the battery at a high rate of discharge.
- Fast charging** - Charges much faster than conventional sealed lead-acid batteries.
- Long cycle life** - More than 3000 cycles at 100% depth of discharge.
- Intelligent BMS** - The battery management system monitors and adapts to battery conditions to maximize performance and safety.

Dimensions & Terminal Type (mm)

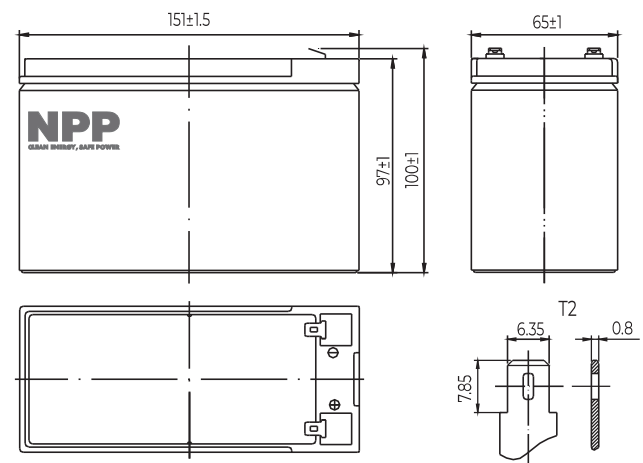

Certification & Compliances



Compliant to: IEC 62133-2

The data in this document is subject to change without notice and become contractual only after written confirmation. Please contact NPP Power for the latest available version.

Guangdong NPP New Energy Co., Ltd.

No.3 Hongli Road, Miaobian Community, Liaobu Town, Dongguan, Guangdong Province, China.

Guangzhou NPP Power Co., Ltd.

No.67 Lianglong Road, Huashan Town, Huadu District, Guangzhou, China.
Email: info@nppower.com.cn Tel: +86 20 37887 390

LFP12.8-8

Lithium iron phosphate battery

LITHIUM

SERIES

Discharge characteristics (25°C)

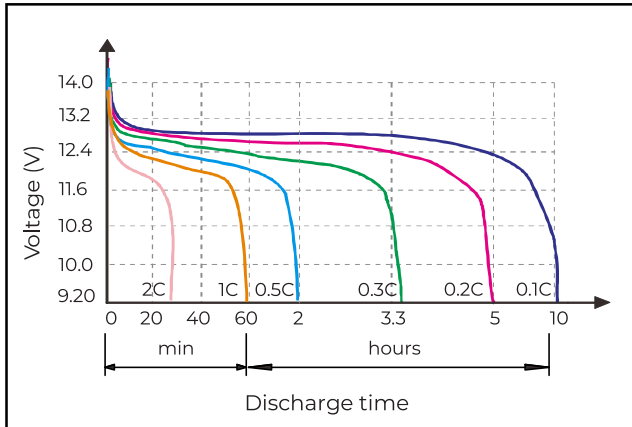

Temperature effects on discharge (0.5C)

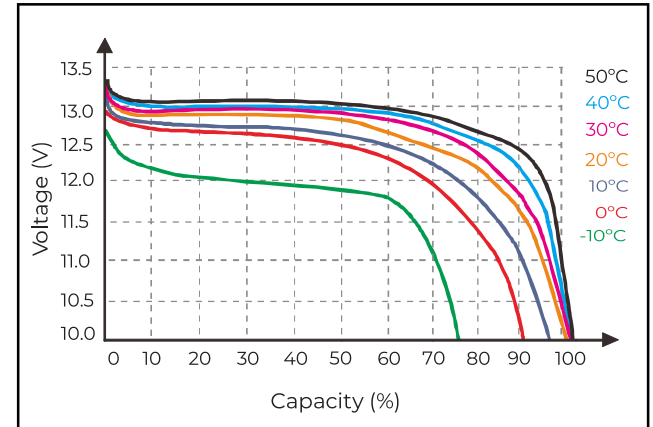

Charging Time on S.O.C. (25°C)

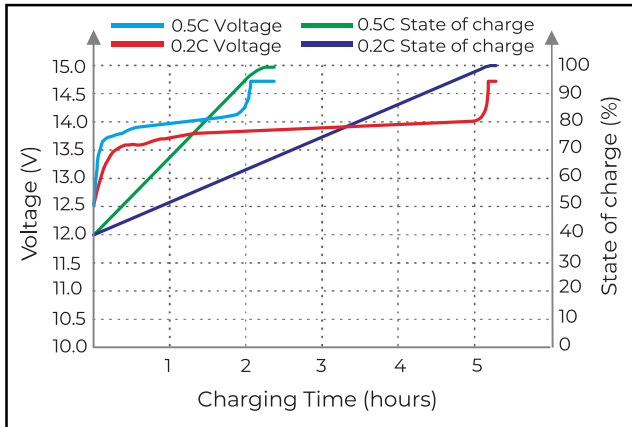

Charge characteristics (25°C)

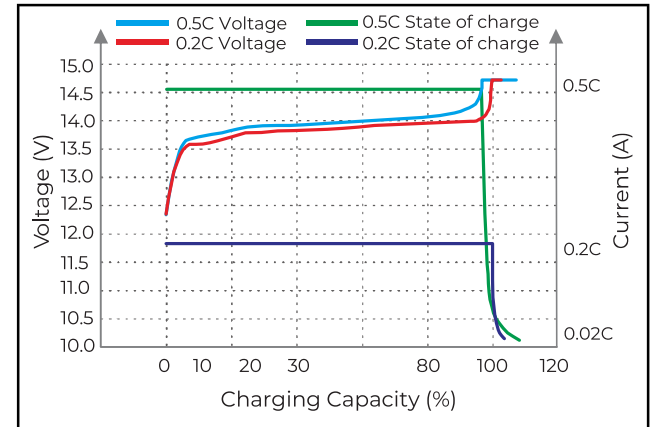

Cycle life on D.O.D. (25°C)

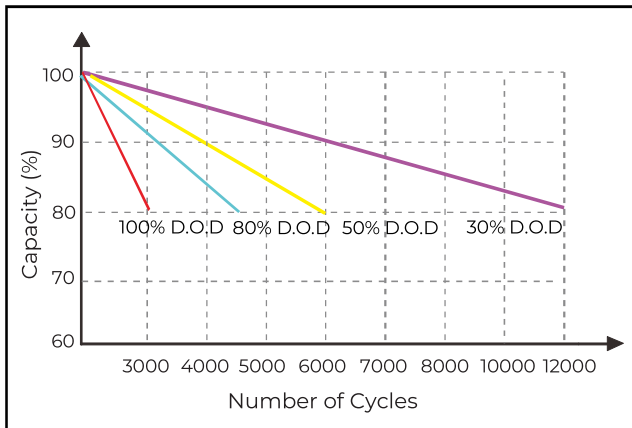

Self discharge characteristics

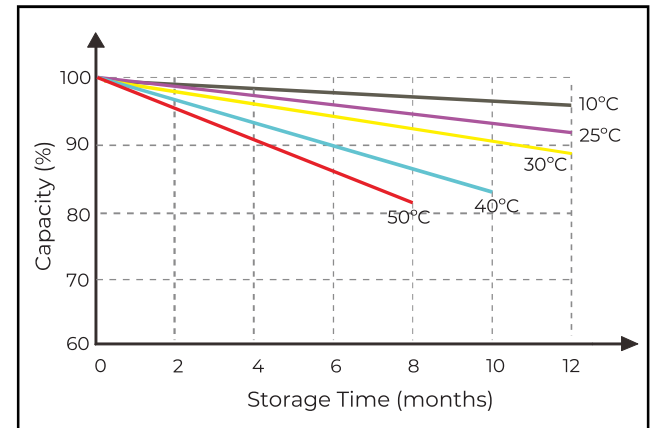

D.O.D. - depth of discharge
S.O.C. - state of charge